



APRIL 21 13:50



APRIL 21 14:50



APRIL 21 15:50



APRIL 21 16:50



APRIL 21 17:50



APRIL 21 18:40

All drawings, specifications, related documents and design are the copyright property of the architect and must be returned upon request. Reproduction of the drawings, specifications, related documents and design in whole or in part is strictly forbidden without the architect's written permission.

This drawing, as an instrument of service, is provided by and is the property of Teepie Architects Inc., and shall be used only for the project named on the drawing and solely for reference purposes only. The contractor is responsible for the coordination and verification of all dimensions contained herein and all measurements and conditions on site as they pertain to these documents. The contractor shall report any discrepancies to the consultant in writing prior to the commencement of any affected work.

DO NOT SCALE THIS DRAWING:
This drawing shall not be used for construction purposes unless countersigned.

Teepie Architects Inc.

NO.	DATE	ISSUED FOR:

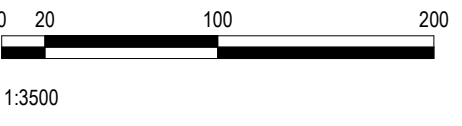

COLOUR LEGEND

- PROPOSED BUILDING SHADOW
- PROPOSED / NOT YET CONSTRUCTED SHADOW
- EXISTING CONTEXT SHADOW
- PARK
- ROAD
- CURB
- CONTEXT MASSING
- RAILROAD

- ARCHITECT**
Teepie Architects Inc.
5 Camden Street, Toronto, ON, Canada, M5V 1Y2
T. 416.598.0554
- STRUCTURAL**
.
- MECHANICAL**
.
- ELECTRICAL**
.
- .

- LANDSCAPE**
Janet Rosenberg & Studio
148 Kenwood Avenue, Toronto, ON M6C 2S3
T. 416.556.0659
- CIVIL**
Trafalgar Engineering Limited
1-481 Morton Road, Oakville, ON, L6K 2W6
T. 905.538.3386

- TRAFFIC**
BA Consulting Group Limited
394-45 St. Clair Avenue West, Toronto, ON, M6Y 1K9
T. 416.961.7110
- SOLID WASTE MANAGEMENT**
R.J. Burnside & Associates Limited
1450 Denison Parkway, Pickering, ON, L1V 7P7
T. 1.800.265.9662
- PLANNING**
Bousfields Inc.
3 Church Street, Toronto, ON, M5E 1M2
T. 416.947.9744
- CLIENT**
Distrikt Developments
1-60 Wingard Avenue, Toronto, ON, Canada M8B 1P5
T. 416.528.9539

DISTRIKT
157 - 165 CROSS
AVE, OAKVILLE
157 & 165 Cross Avenue, Oakville, ON, Canada

N
ONTARIO ASSOCIATION OF ARCHITECTS
SEAL

SHADOW STUDIES
APRIL

Author	Checker
DRAWN BY: 23-107	CHECKED BY: 1:1 ARCH E
PROJ. NO.	SCALE: 1:1 ARCH E FORMAT: 01/26/24 PLOT DATE

All drawings, specifications, related documents and design are the copyright property of the architect and must be returned upon request. Reproduction of the drawings, specifications, related documents and design in whole or in part is strictly forbidden without the architect's written permission.

This drawing is an instrument of service, is provided by and is the property of Teepie Architects Inc., and shall be used only for the project named on the drawing and solely for reference purposes only. The contractor is responsible for the coordination and verification of all dimensions contained herein and all measurements and conditions on site as they pertain to these documents. The contractor shall report any discrepancies to the consultant in writing prior to the commencement of any affected work.

DO NOT SCALE THIS DRAWING.
This drawing shall not be used for construction purposes unless countersigned!

Teepie Architects Inc.

NO.	DATE:	ISSUED FOR:

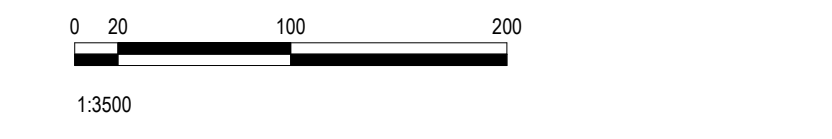



COLOUR LEGEND

- PROPOSED BUILDING SHADOW
- PROPOSED / NOT YET CONSTRUCTED SHADOW
- EXISTING CONTEXT SHADOW
- PARK
- ROAD
- CURB
- CONTEXT MASSING**
- RAILROAD

- ARCHITECT**
Teepie Architects Inc.
5 Camden Street, Toronto, ON, Canada, M5V 1V2
T: 416.598.0554
- STRUCTURAL**
.
- MECHANICAL**
.
- ELECTRICAL**
.
- LANDSCAPE**
Janet Rosenberg & Studio
148 Kenwood Avenue, Toronto, ON M6C 2S3
T: 416.598.6669
- CIVIL**
Trafalgar Engineering Limited
1-481 Modern Road, Oakville, ON, L6K 2W6
T: 905.508.3088
- TRAFFIC**
BA Consulting Group Limited
384-45 St. Clair Avenue West, Toronto, ON, M6Y 1K9
T: 416.961.7110
- SOLID WASTE MANAGEMENT**
R.J. Burnside & Associates Limited
140 Pickering Parkway, Pickering, ON L1V 7G7
T: 1.800.265.9662
- PLANNING**
Bousfields Inc.
3 Church Street, Toronto, ON, M5E 1M2
T: 416.947.9744
- CLIENT**
Distrikt Developments
1-60 Wingard Avenue, Toronto, ON, Canada M9B 1P5
T: 416.553.9539

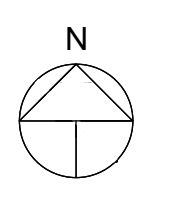
**DISTRIKT**
**157 - 165 CROSS
AVE, OAKVILLE**
157 & 165 Cross Avenue, Oakville, ON, Canada

N 



**SHADOW STUDIES
JUNE**

Author	Checker
23-107	1:1
PRJ.D	ARCH E
NO	SCALE
	FORMAT
	DATE

A1003

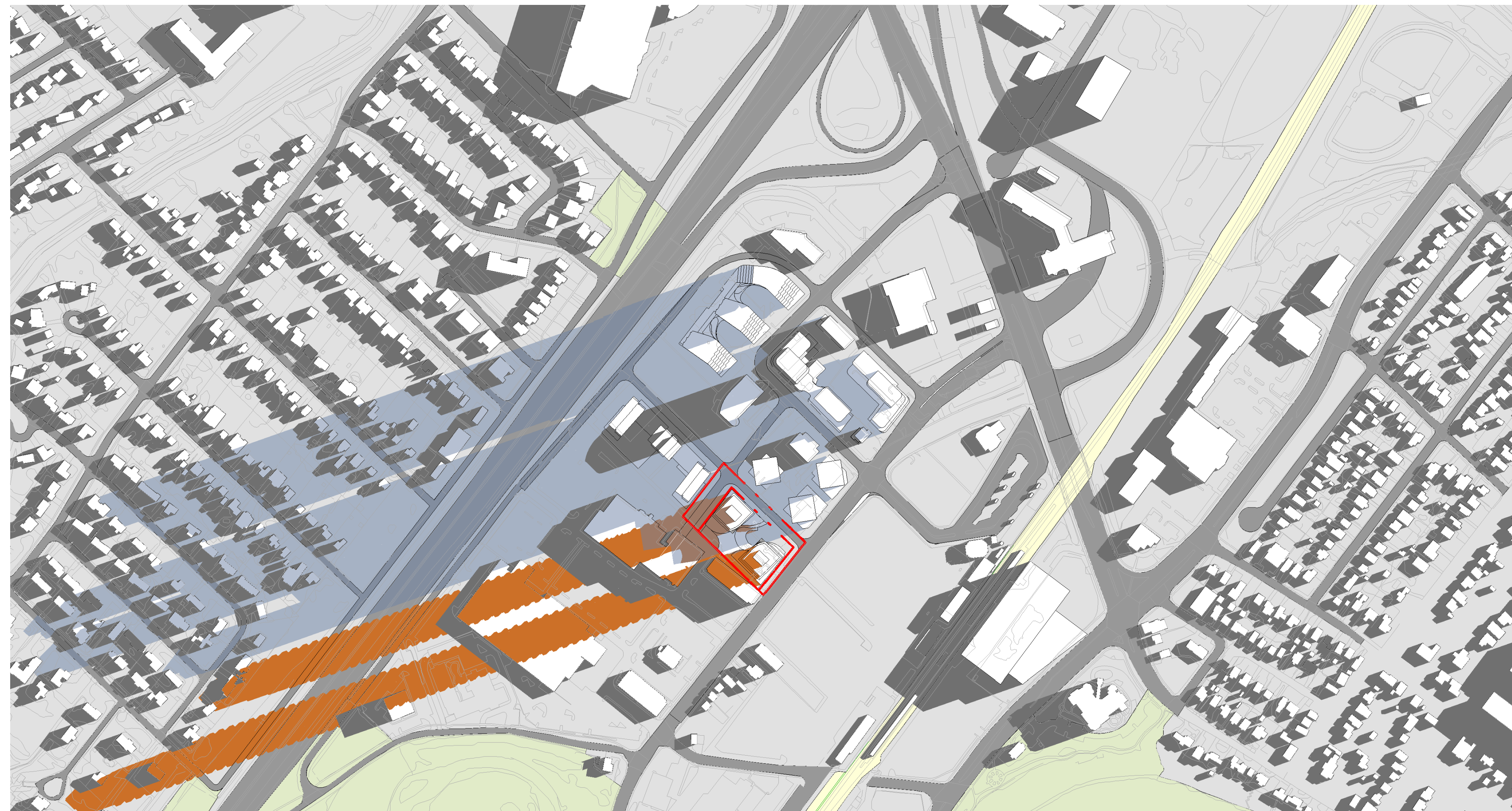

JUNE 21 07:08



JUNE 21 8:08



JUNE 21 09:08



JUNE 21 10:08

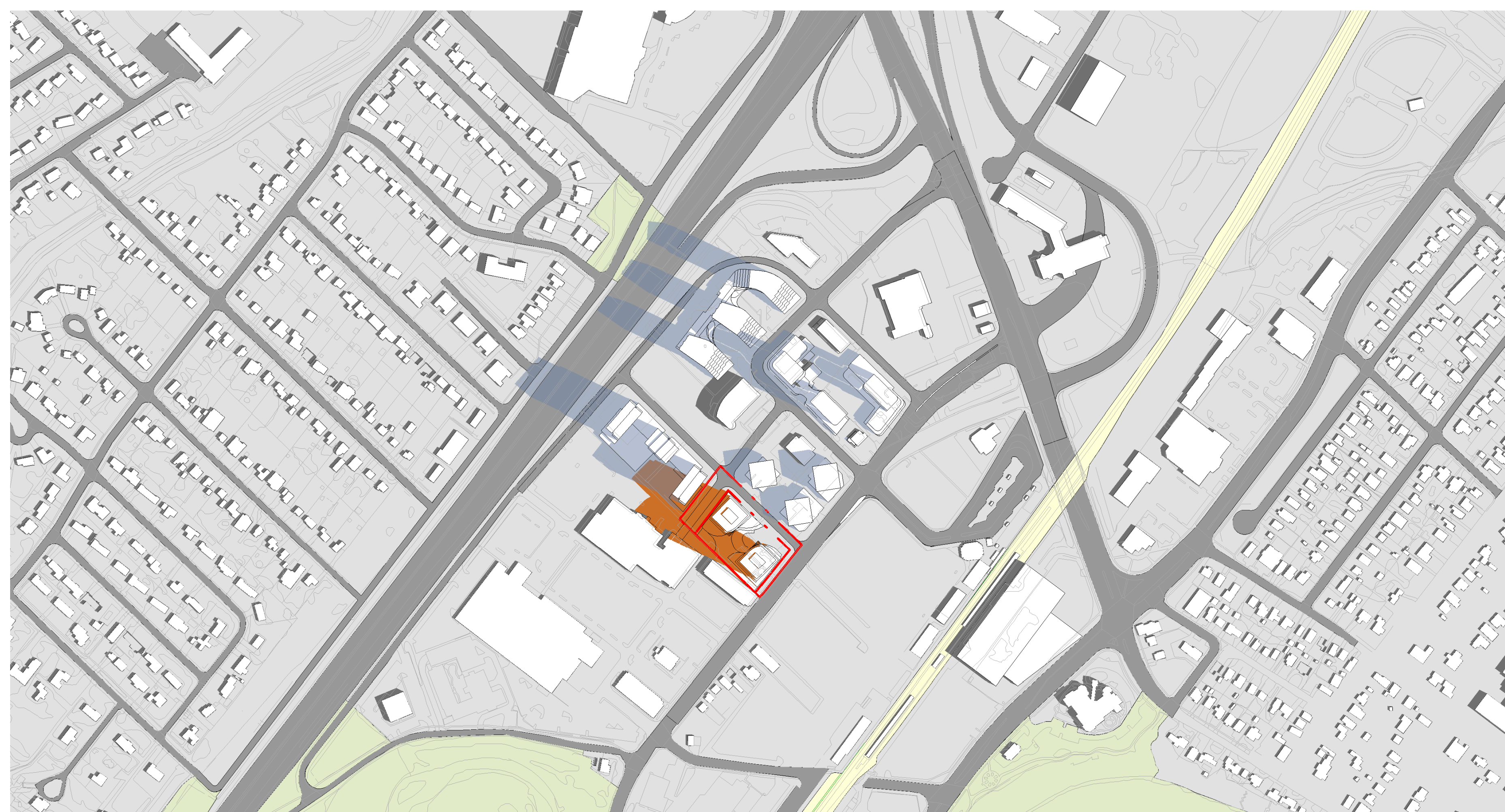

JUNE 21 11:08



JUNE 21 12:08



JUNE 21 13:08



JUNE 21 14:08



JUNE 21 15:08



JUNE 21 16:08

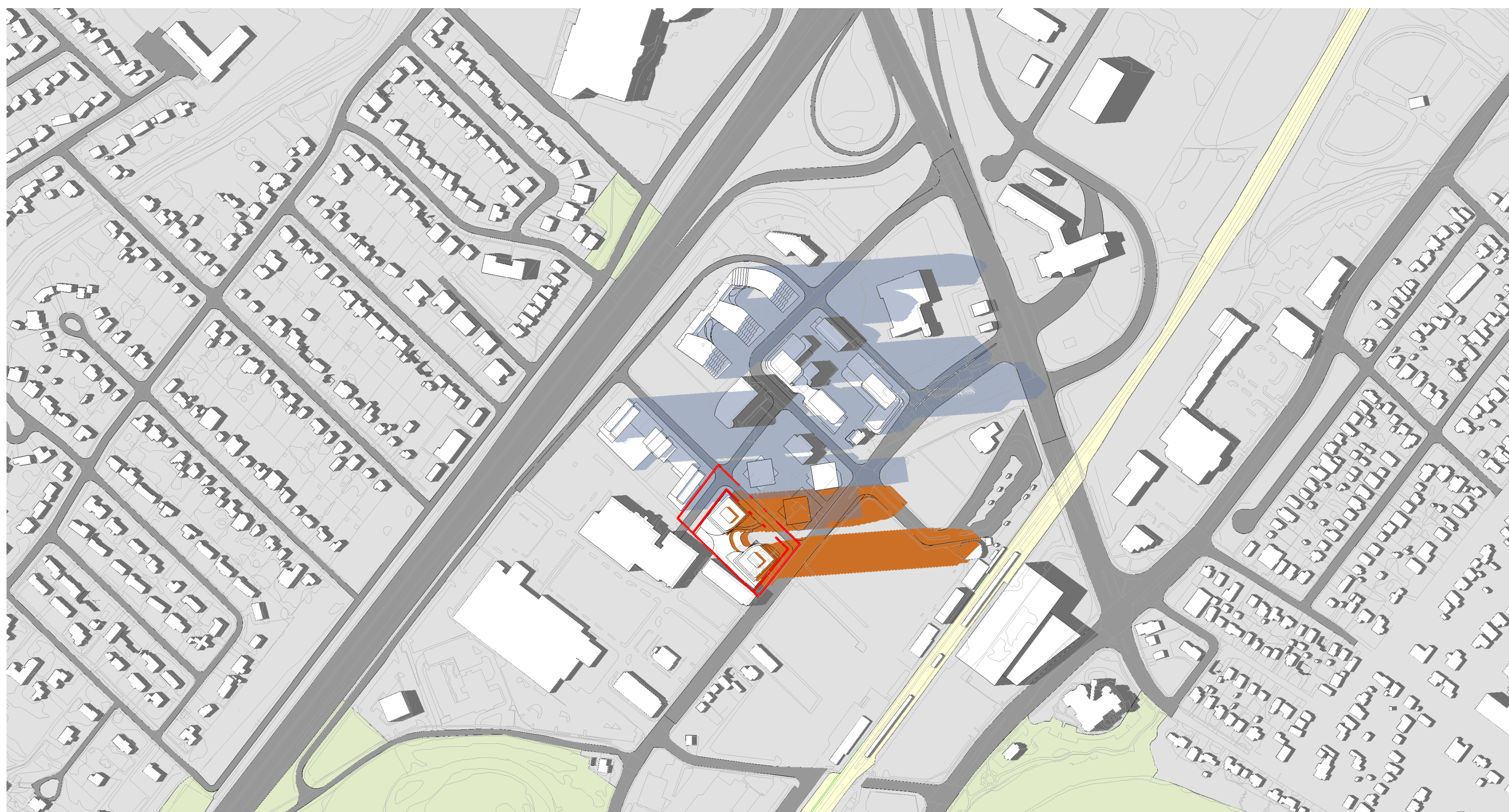

JUNE 21 17:08

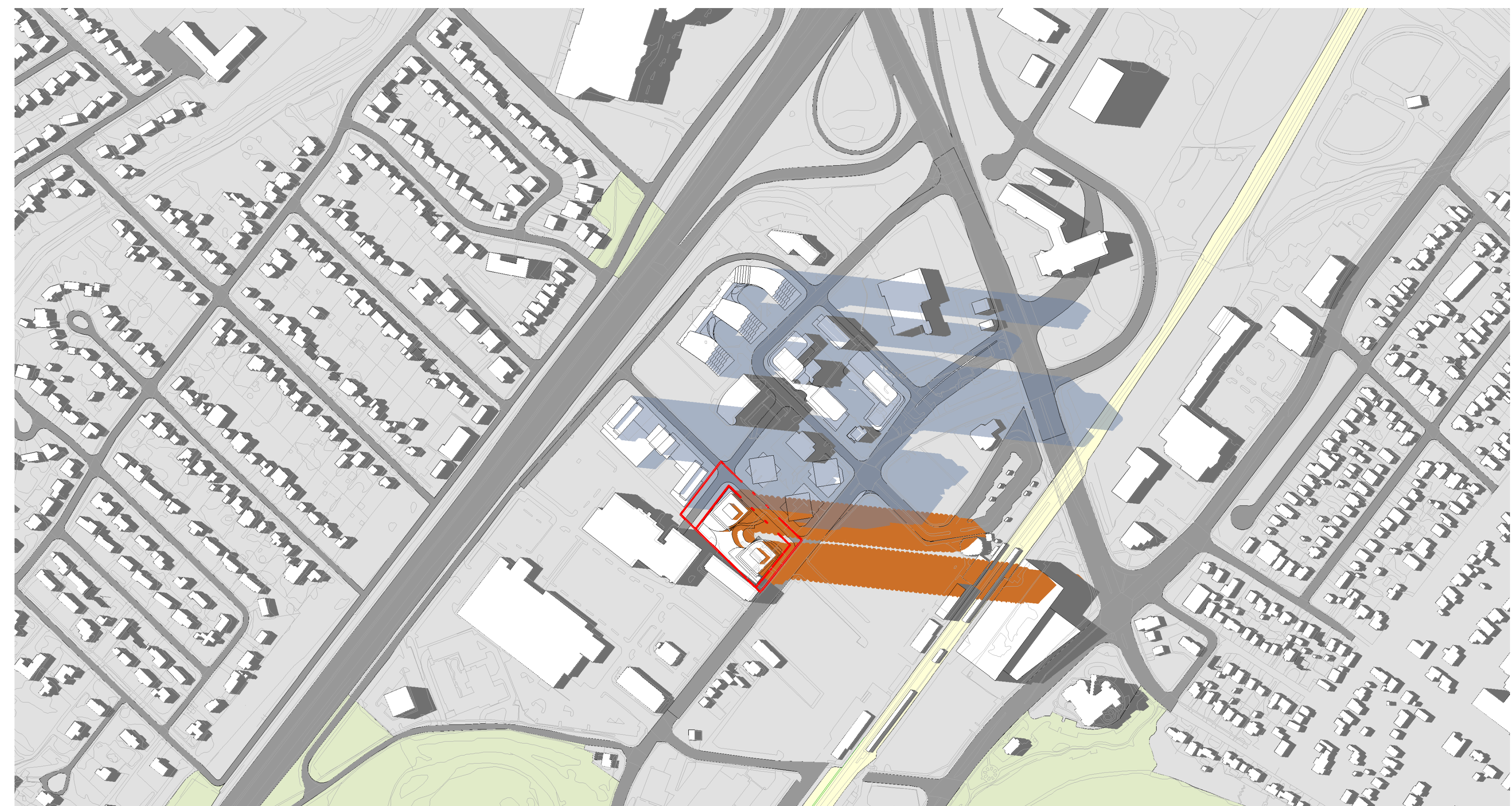

JUNE 21 18:08

NO.	DATE	ISSUED FOR:



COLOUR LEGEND

	PROPOSED BUILDING SHADOW
	PROPOSED / NOT YET CONSTRUCTED SHADOW
	EXISTING CONTEXT SHADOW
	PARK
	ROAD
	CURB
	RAILROAD

ARCHITECT
Teepie Architects Inc.
 5 Camden Street, Toronto, ON, Canada, M5V 1V2
 T: 416.598.0554

STRUCTURAL
 .

MECHANICAL
 .

ELECTRICAL
 .

LANDSCAPE
Janet Rosenberg & Studio
 148 Kenwood Avenue, Toronto, ON M6C 2S3
 T: 416.556.6659

CIVIL
Trafalgar Engineering Limited
 1-881 Modern Road, Oakville, ON L6K 2W6
 T: 905.538.3368

TRAFFIC
BA Consulting Group Limited
 284-45 St. Clair Avenue West, Toronto, ON M4V 1K9
 T: 416.961.7110

SOLID WASTE MANAGEMENT
R.J. Burnside & Associates Limited
 1461 Pickering Parkway, Pickering, ON L1W 7P7
 T: 1.800.265.9662

PLANNING
Bousfields Inc.
 3 Church Street, Toronto, ON, M5E 1M2
 T: 416.947.9744

CLIENT
District Developments
 1-60 Wingoos Avenue, Toronto, ON, Canada M8B 1P5
 T: 416.528.9539

DISTRIKT
157 - 165 CROSS
AVE, OAKVILLE
 157 & 165 Cross Avenue, Oakville, ON, Canada

N

SEAL

SHADOW STUDIES
JUNE

Author	Checker
23-107	1:1
PROJ NO	SCALE
	ARCH E
	FORMAT
	01/26/24
	PLOT DATE

A1004



JUNE 21 19:08



JUNE 21 19:33

All drawings, specifications, related documents and design are the copyright property of the architect and must be returned upon request. Reproduction of the drawings, specifications, related documents and design in whole or in part is strictly forbidden without the architect's written permission.

This drawing is an instrument of service, is provided by and is the property of Teepie Architects Inc., and shall be used only for the project named on this drawing and solely for reference purposes only. The contractor is responsible for the coordination and verification of all dimensions contained herein and all measurements and conditions on site as they pertain to these documents. The contractor shall report any discrepancies to the consultant in writing prior to the commencement of any affected work.

DO NOT SCALE THIS DRAWING
This drawing shall not be used for construction purposes unless countersigned.

Teepie Architects Inc.

NO.	DATE	ISSUED FOR:

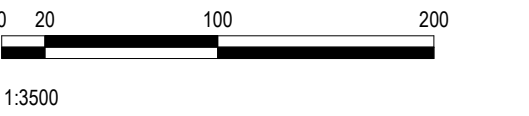

COLOUR LEGEND

- PROPOSED BUILDING SHADOW
- PROPOSED / NOT YET CONSTRUCTED SHADOW
- EXISTING CONTEXT SHADOW
- PARK
- ROAD
- CURB
- CONTEXT MASSING
- RAILROAD

ARCHITECT
Teepie Architects Inc.
5 Camden Street, Toronto, ON, Canada, M5V 1Y2
T: 416.598.0554

STRUCTURAL
-

MECHANICAL
-

ELECTRICAL
-

LANDSCAPE
Janet Rosenberg & Studio
148 Kenwood Avenue, Toronto, ON M8C 2S3
T: 416.598.0659

CIVIL
Trafalgar Engineering Limited
1-451 Modern Road, Oakville, ON, L6K 2W6
T: 905.338.3366

TRAFFIC
BA Consulting Group Limited
398-45 St. Clair Avenue West, Toronto, ON, M6Y 1K9
T: 416.961.7110

SOLID WASTE MANAGEMENT
R.J. Burnside & Associates Limited
1465 Pickering Highway, Pickering, ON, L1V 7G7
T: 1.800.265.9662

PLANNING
Bousfields Inc.
3 Church Street, Toronto, ON, M5E 1M2
T: 416.947.9744

CLIENT
Distrikt Developments
1-60 Wingo Avenue, Toronto, ON, Canada M8B 1P5
T: 416.453.8038

DISTRIKT
157 - 165 CROSS
AVE, OAKVILLE

157 & 165 Cross Avenue, Oakville, ON, Canada

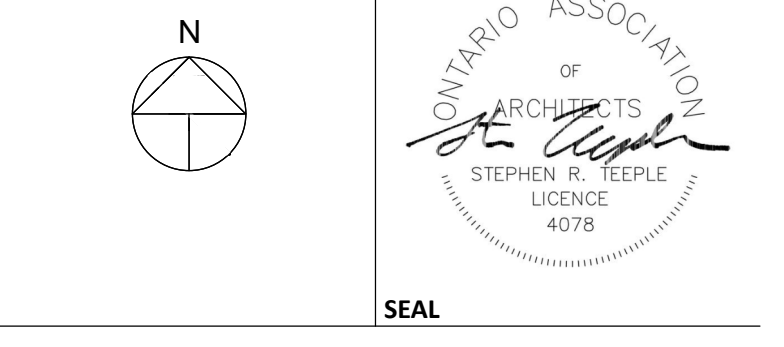

SHADOW STUDIES
JUNE

Author	Checker
DRAWN BY	CHECKED BY
23-107	1:1
PROJ. NO	SCALE
	ARCH E
	FORMAT
	01/26/24
	PLOT DATE

A1005

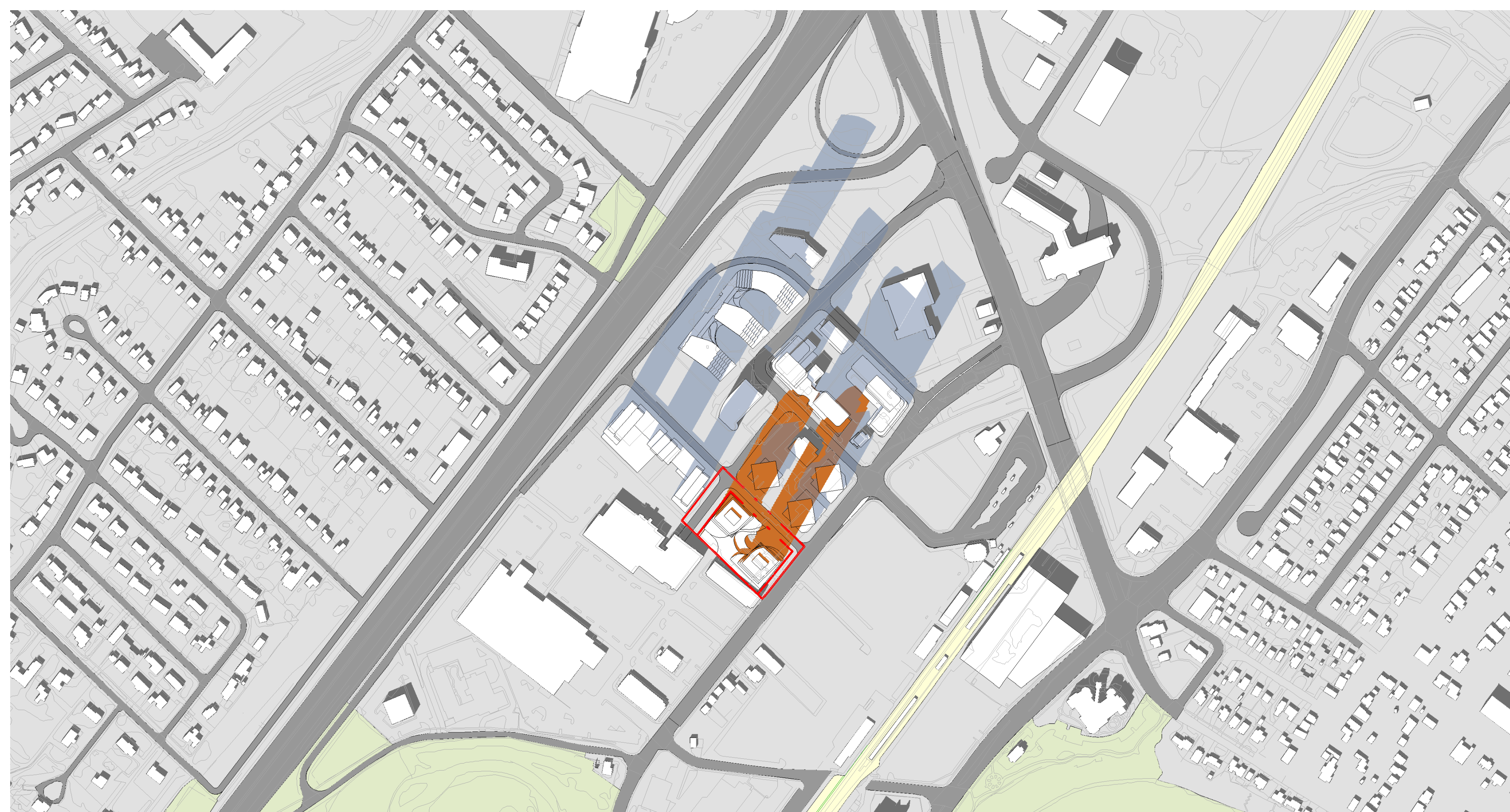

SEPT 21 14:36



SEPT 21 15:36



SEPT 21 16:36

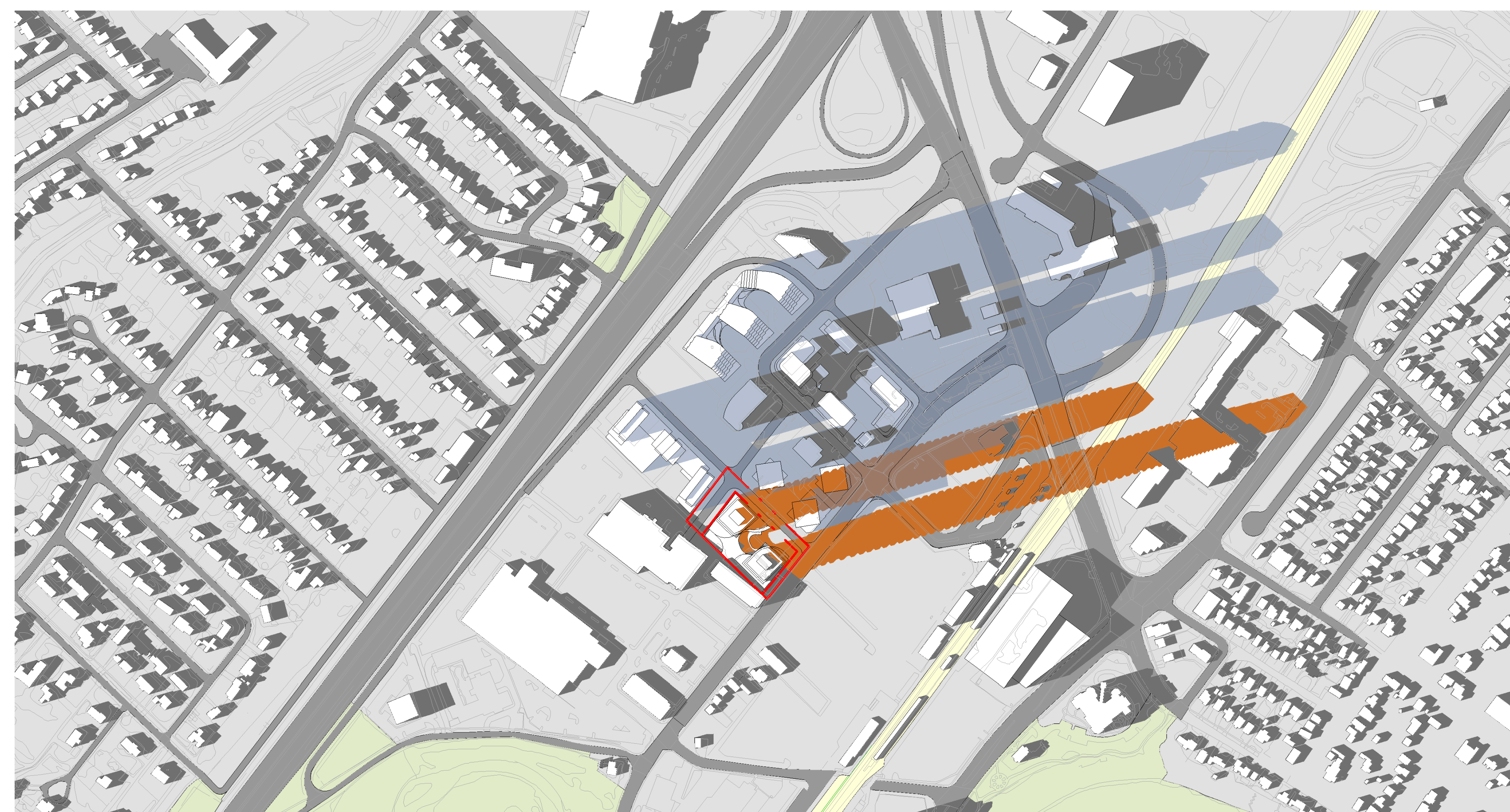

SEPT 21 17:36

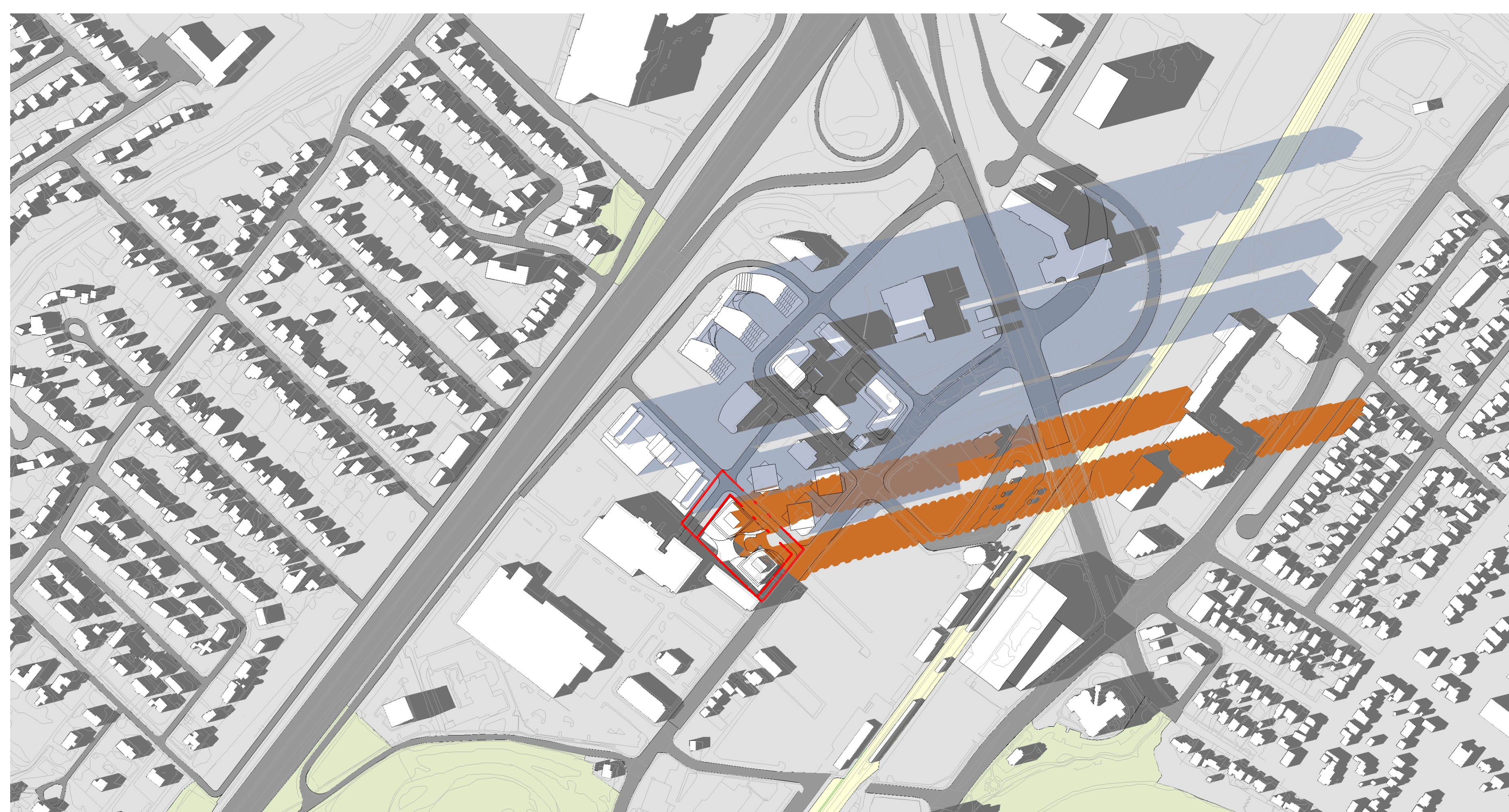

SEPT 21 17:47

All drawings, specifications, related documents and design are the copyright property of the architect and must be returned upon request. Reproduction of the drawings, specifications, related documents and design in whole or in part is strictly forbidden without the architect's written permission.

This drawing is an instrument of service, is provided by and is the property of Teepie Architects Inc., and shall be used only for the project named on the drawing and solely for reference purposes only. The contractor is responsible for the coordination and verification of all dimensions contained herein and all measurements and conditions on site as they pertain to these documents. The contractor shall report any discrepancies to the consultant in writing prior to the commencement of any affected work.

DO NOT SCALE THIS DRAWING
This drawing shall not be used for construction purposes unless countersigned.

Teepie Architects Inc.

NO.	DATE	ISSUED FOR:



COLOUR LEGEND

	PROPOSED BUILDING SHADOW
	PROPOSED / NOT YET CONSTRUCTED SHADOW
	EXISTING CONTEXT SHADOW
	PARK
	ROAD
	CURB
	RAILROAD

CONTEXT MASSING

- RAILROAD

ARCHITECT
Teepie Architects Inc.
5 Camden Street, Toronto, ON, Canada, M5V 1V2
T: 416.598.0554

STRUCTURAL
.

MECHANICAL
.

ELECTRICAL
.

LANDSCAPE
Janet Rosenberg & Studio
148 Kerwood Avenue, Toronto, ON M8C 2S3
T: 416.598.0555

CIVIL
Trafalgar Engineering Limited
1-481 Morden Road, Oakville, ON, L6K 2W6
T: 905.338.3088

TRAFFIC
BA Consulting Group Limited
398-45 St. Clair Avenue West, Toronto, ON, M6Y 1K9
T: 416.961.7110

SOLID WASTE MANAGEMENT
R.J. Burnside & Associates Limited
1465 Pickering Parkway, Pickering, ON, L1V 7P7
T: 1.800.265.9662

PLANNING
Bousfields Inc.
3 Church Street, Toronto, ON, M5E 1M2
T: 416.947.9744

CLIENT
Distrikt Developments
1-50 Wingo Avenue, Toronto, ON, Canada M8B 1P5
T: 416.453.8038

DISTRIKT
157 - 165 CROSS
AVE, OAKVILLE

157 & 165 Cross Avenue, Oakville, ON, Canada

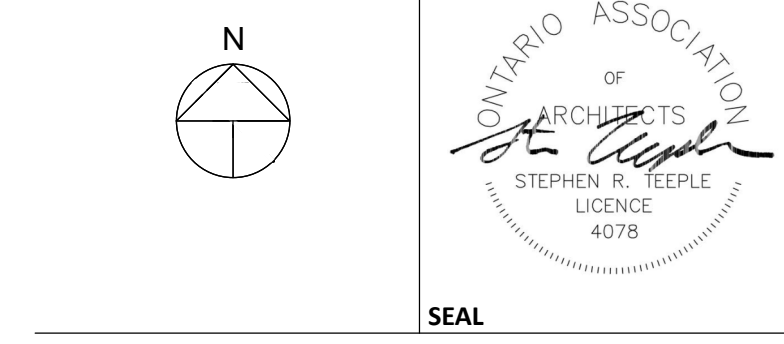

SHADOW STUDIES
SEPTEMBER

Author	Checker
DRAWN BY 23-107	CHECKED BY 1:1 ARCH E
PROJ NO SCALE	FORMAT PLOT DATE

A1007

All drawings, specifications, related documents and design are the copyright property of the architect and must be returned upon request. Reproduction of the drawings, specifications, related documents and design in whole or in part is strictly forbidden without the architect's written permission.

This drawing is an instrument of service. It is provided by and is the property of Teepie Architects Inc., and shall be used only for the project named on this drawing and solely for reference purposes only. The contractor is responsible for the coordination and verification of all dimensions contained herein and all measurements and conditions on site as they pertain to these documents. The contractor shall report any discrepancies to the consultant in writing prior to the commencement of any affected work.

DO NOT SCALE THIS DRAWING
 This drawing shall not be used for construction purposes unless counterchecked!

Teepie Architects Inc.

NO.	DATE:	ISSUED FOR:



- COLOUR LEGEND**
- PROPOSED BUILDING SHADOW
 - PROPOSED / NOT YET CONSTRUCTED SHADOW
 - EXISTING CONTEXT SHADOW
 - PARK
 - ROAD
 - CURB
 - CONTEXT MASSING
 - RAILROAD

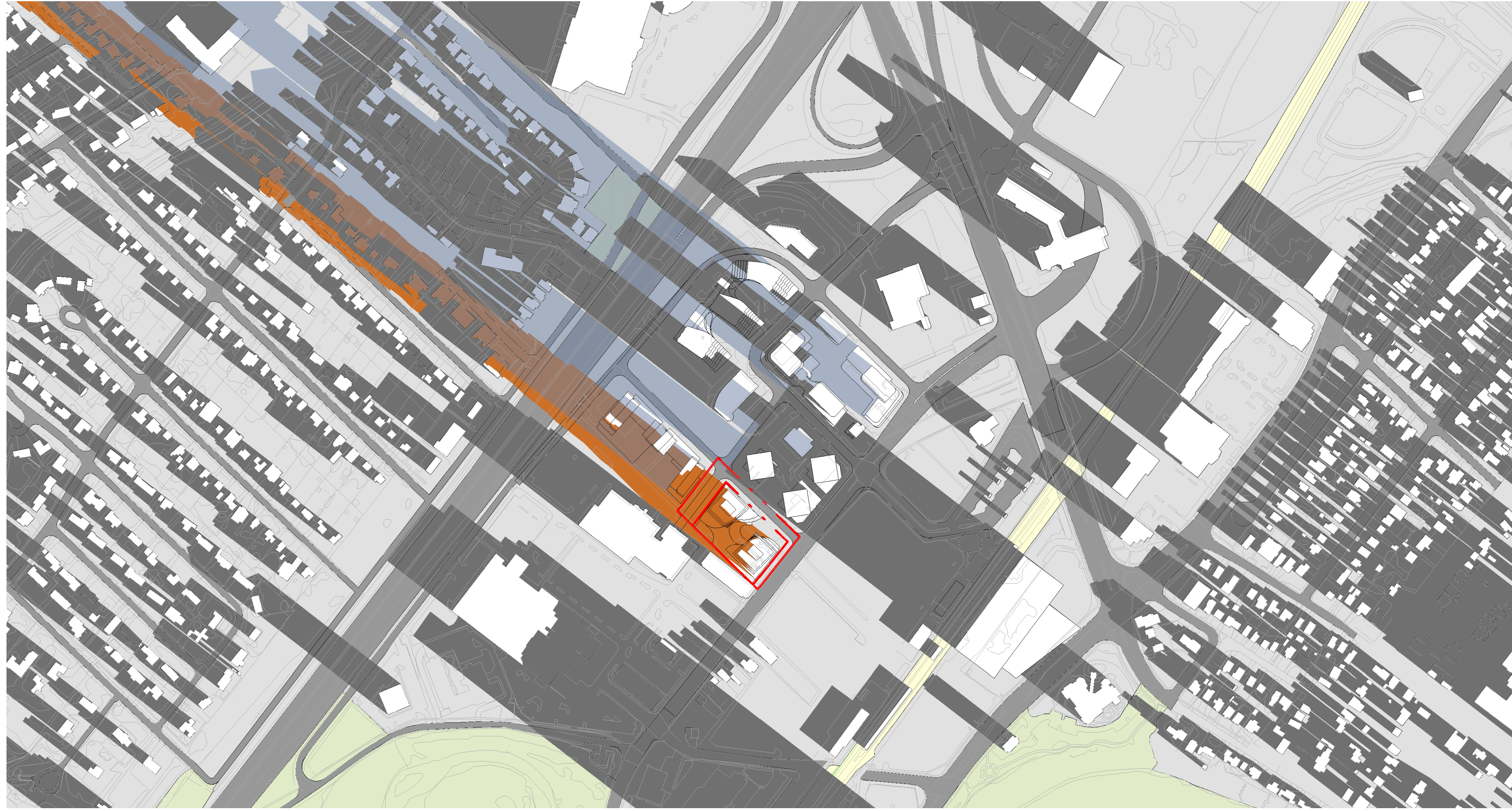

DEC 21 09:19

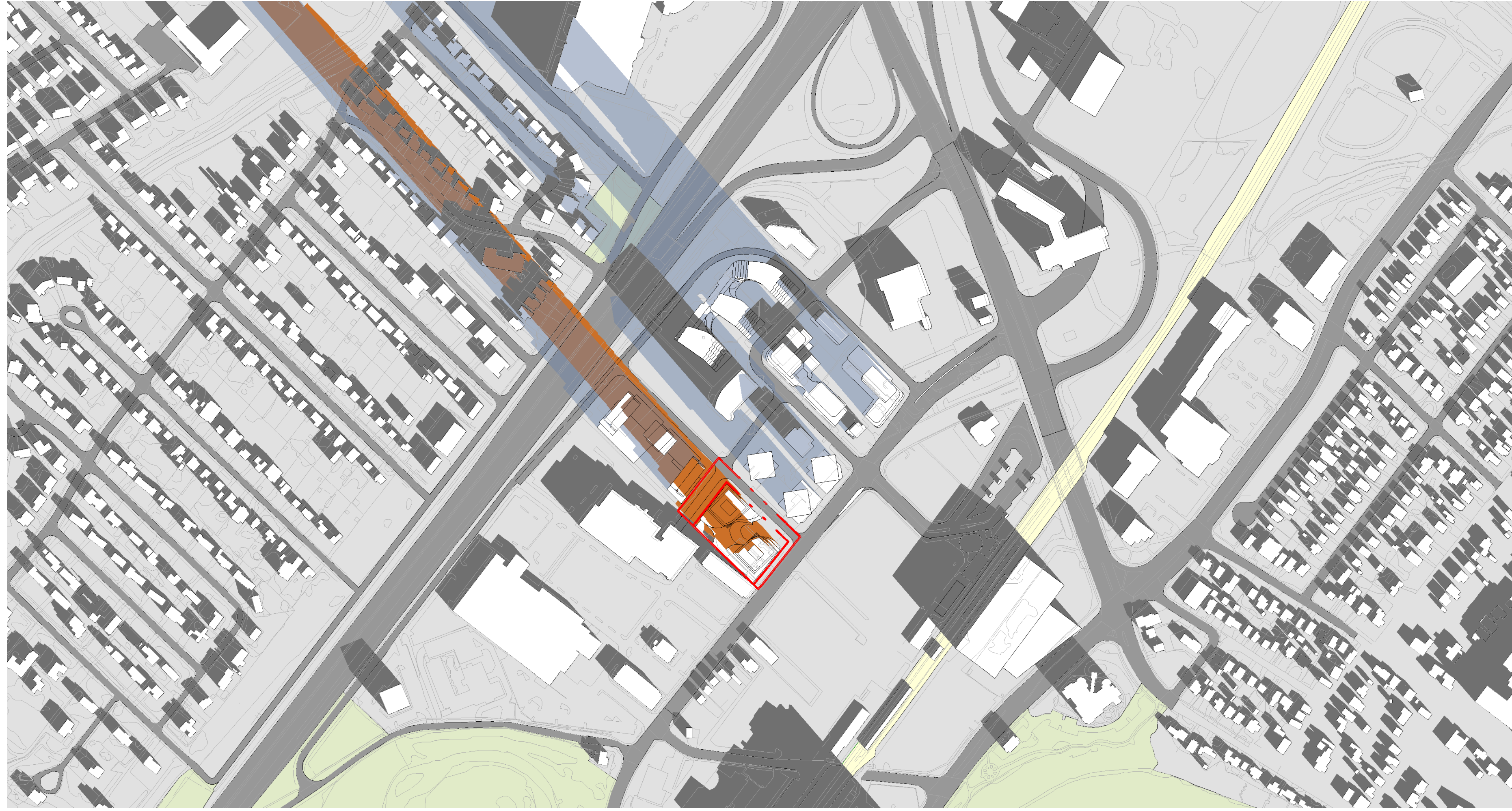

DEC 21 10:19



DEC 21 11:19



DEC 21 12:19



DEC 21 13:19

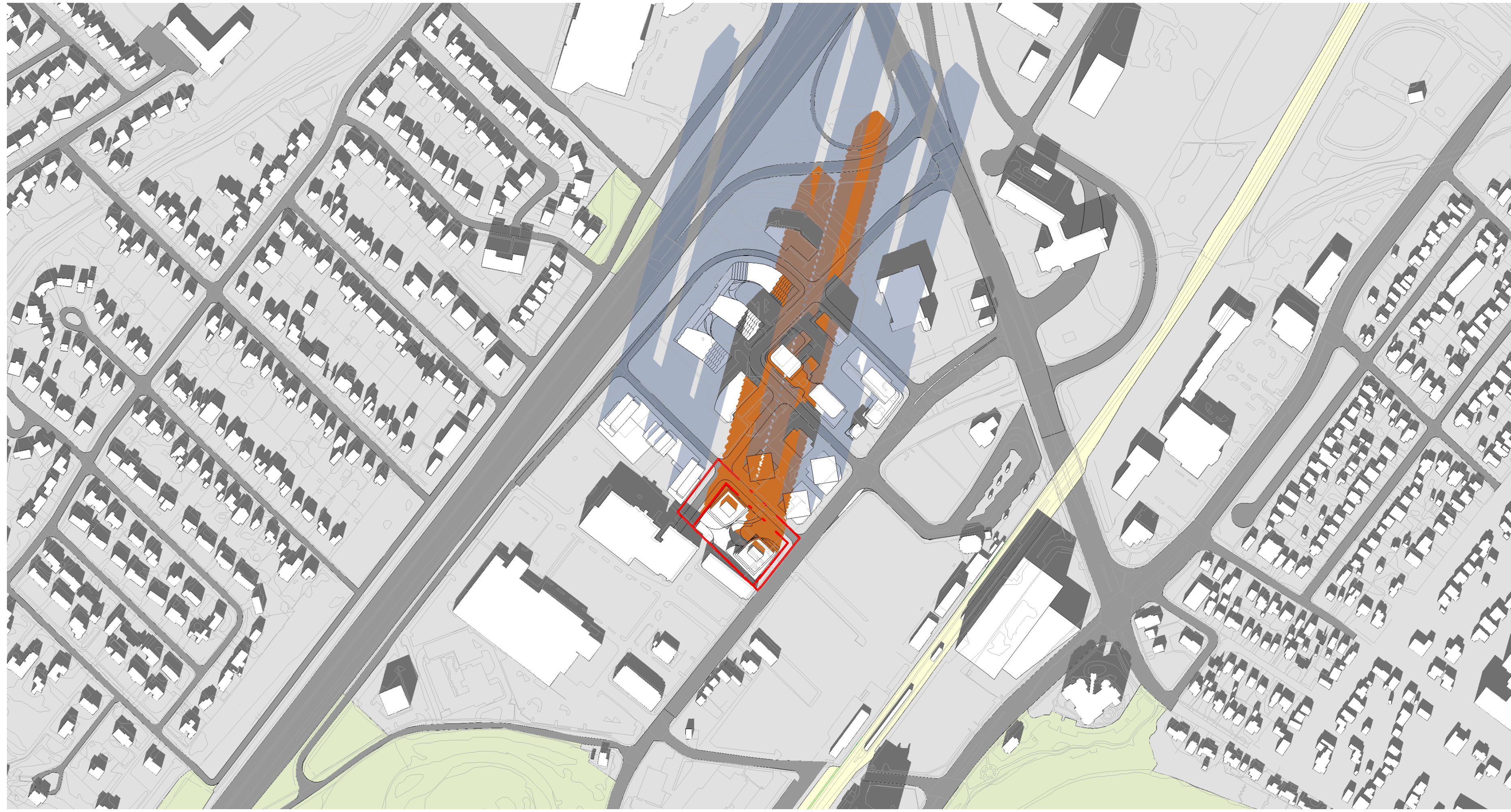

DEC 21 14:19

ARCHITECT
Teepie Architects Inc.
 5 Camden Street, Toronto, ON, Canada, M8V 1V2
 T. 416.598.0554

STRUCTURAL

MECHANICAL

ELECTRICAL

LANDSCAPE
Janet Rosenberg & Studio
 148 Kenwood Avenue, Toronto, ON M6C 2S3
 T. 416.556.9659

CIVIL
Trafalgar Engineering Limited
 1-481 Morton Road, Oakville, ON L6K 2W6
 T. 905.538.3986

TRAFFIC
BA Consulting Group Limited
 284-45 St. Clair Avenue West, Toronto, ON M8V 1K9
 T. 416.961.7110

SOLID WASTE MANAGEMENT
R.J. Burridge & Associates Limited
 1450 Finchley Parkway, Pickering, ON L1V 7P2
 T. 1.800.265.9962

PLANNING
Bousfields Inc.
 3 Church Street, Toronto, ON, M5E 1M2
 T. 416.947.9744

CLIENT
District Developments
 1-50 Wingard Avenue, Toronto, ON, Canada M8B 1P5
 T. 416.528.8038

DISTRIKT
157 - 165 CROSS
AVE, OAKVILLE

157 & 165 Cross Avenue, Oakville, ON, Canada

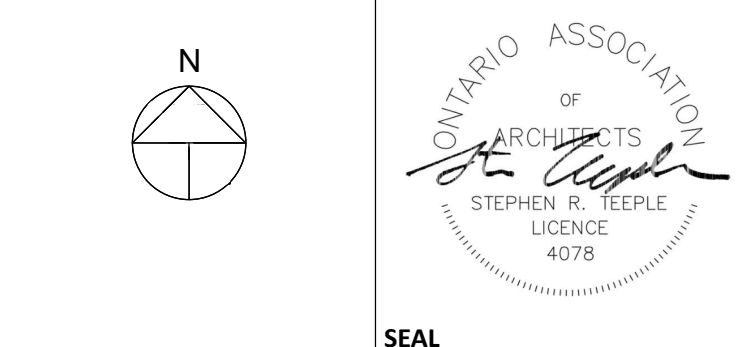

SHADOW STUDIES
DECEMBER

Author	Checker
DRAWN BY 23-107 PRJ NO	CHECKED BY 1:1 SCALE ARCH E FORMAT 01/26/24 PLOT DATE



DEC 21 15:16

All drawings, specifications, related documents and design are the copyright property of the architect and must be returned upon request. Reproduction of the drawings, specifications, related documents and design in whole or in part is strictly forbidden without the architect's written permission.

This drawing is an instrument of service, is provided by and is the property of Teepie Architects Inc., and shall be used only for the project named on the drawing and solely for reference purposes only. The contractor is responsible for the coordination and verification of all dimensions contained herein and all measurements and conditions on site as they pertain to these documents. The contractor shall report any discrepancies to the consultant in writing prior to the commencement of any affected work.

DO NOT SCALE THIS DRAWING
This drawing shall not be used for construction purposes unless countersigned.

Teepie Architects Inc.

NO.	DATE	ISSUED FOR:

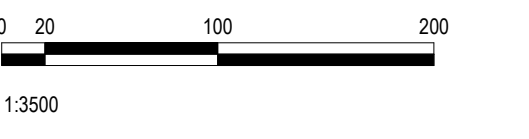

COLOUR LEGEND

- PROPOSED BUILDING SHADOW
- PROPOSED / NOT YET CONSTRUCTED SHADOW
- EXISTING CONTEXT SHADOW
- PARK
- ROAD
- CURB
- CONTEXT MASSING
- RAILROAD

ARCHITECT
Teepie Architects Inc.
5 Camden Street, Toronto, ON, Canada, M5V 1V2
T: 416.598.0554

STRUCTURAL
-

MECHANICAL
-

ELECTRICAL
-

LANDSCAPE
Janet Rosenberg & Studio
148 Kenwood Avenue, Toronto, ON M6C 2S3
T: 416.598.0554

CIVIL
Trafalgar Engineering Limited
1-481 Morden Road, Oakville, ON, L6K 2W6
T: 905.338.3366

TRAFFIC
BA Consulting Group Limited
398-45 St. Clair Avenue West, Toronto, ON, M6Y 1K9
T: 416.961.7110

SOLID WASTE MANAGEMENT
R.J. Burnside & Associates Limited
1465 Pickering Parkway, Pickering, ON, L1V 7G7
T: 1.800.265.9662

PLANNING
Bousfields Inc.
3 Church Street, Toronto, ON, M5E 1M2
T: 416.947.9744

CLIENT
District Developments
1-60 Wingate Avenue, Toronto, ON, Canada M9B 1P5
T: 416.453.8038

DISTRIKT
157 - 165 CROSS
AVE, OAKVILLE

157 & 165 Cross Avenue, Oakville, ON, Canada

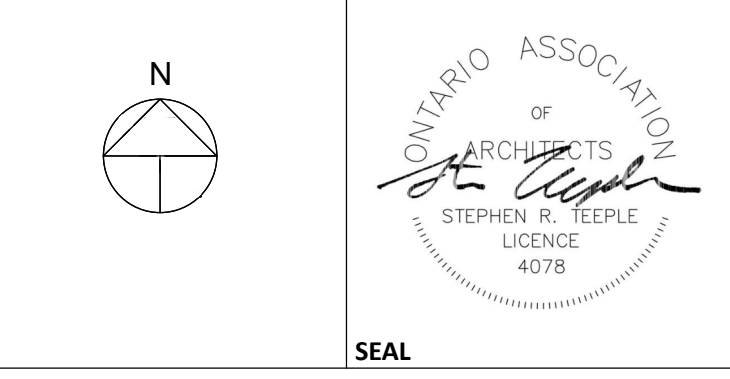

SHADOW STUDIES
DECEMBER

Author	Checker
DRAWN BY	CHECKED BY
23-107	1 : 1 ARCH E
PRJ.D NO	SCALE FORMAT
	O1/26/24 PLOT DATE

A1009